

SR CASTLES

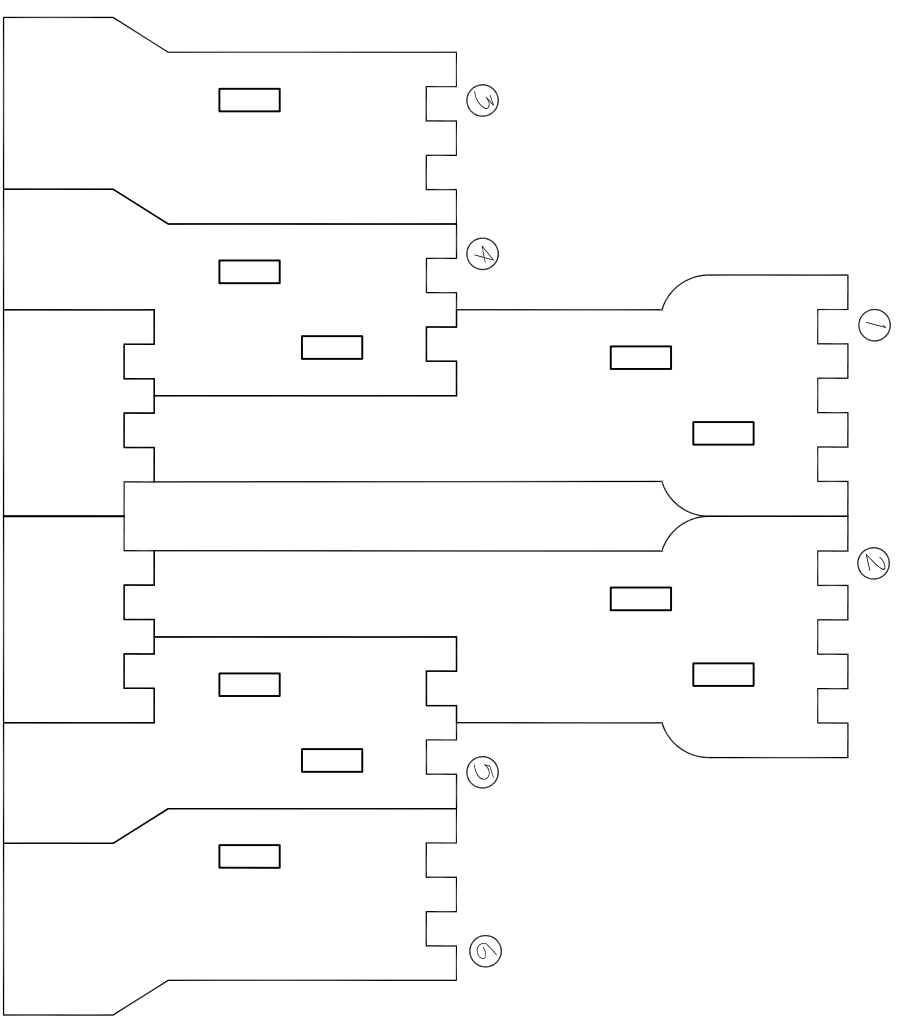

THIS SHOULD BE SHOWN FROM THE CORNER TO THE DECK SOUTHWAY.

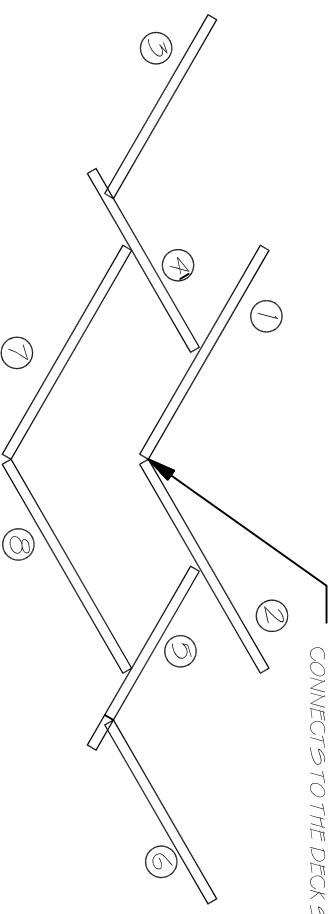

THESE SHOULD OPEN AND CLOSE EASILY LIKE CUTOUTS IN A POPUP-BOOK. SINGROW! MIGHT BE IDEAL FOR THESE TO KEEP THEM SQUARE AND SIMPLE.

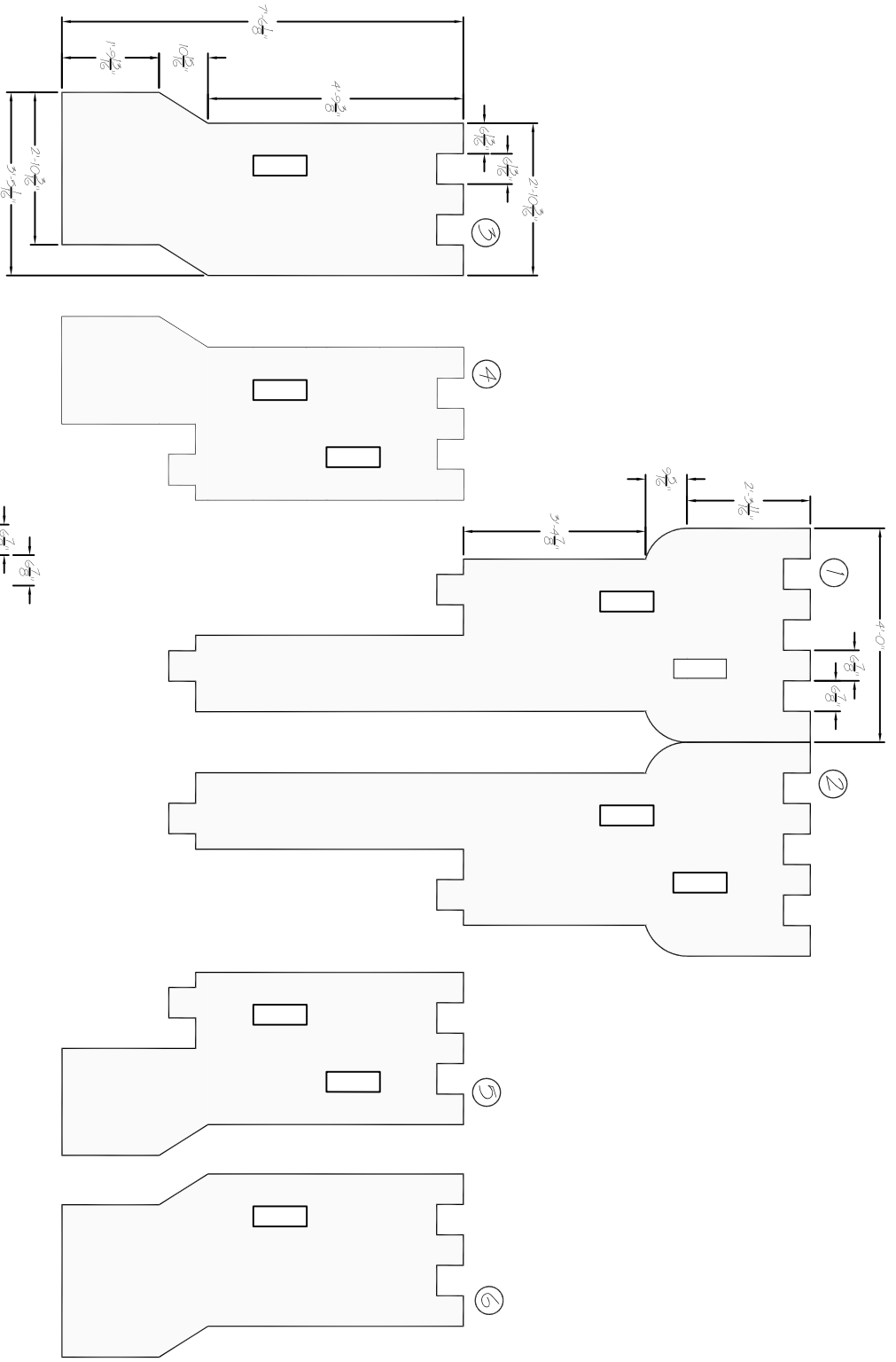

THESE CAN BE PROJECTED OR GRIDDED ONTO PLYWOOD PANELS OR FLYWOOD. THEY SHOULD RING TOGETHER AS SHOWN, BUT OTHERWISE THE DIMENSIONS CAN DRIFT A LITTLE AS THEY ARE DRAN WITHIN PERIAPS AN INCH IF THAT IS HELPFUL.

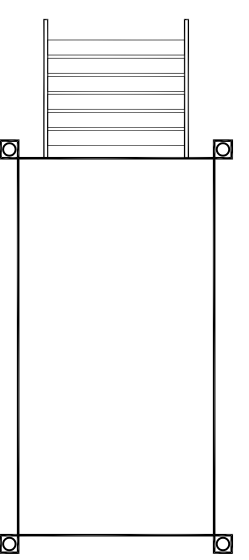

THIS SHOULD BE SHOWN FROM THE CORNER TO THE DECK SOUTHWAY. NO ONE WILL STAND ON IT. IT WILL HAVE AND ONLY ONE. WE OF THEM! THE TOPS SHOULD BE FOUR INCHES THICK.

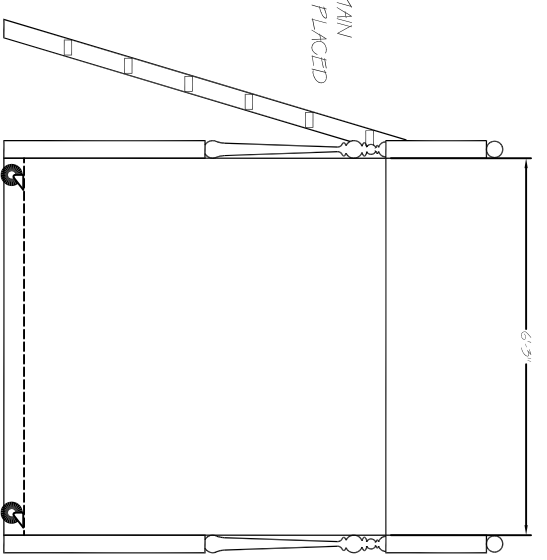

THIS SHOULD BE SHOWN FROM THE CORNER TO THE DECK SOUTHWAY.

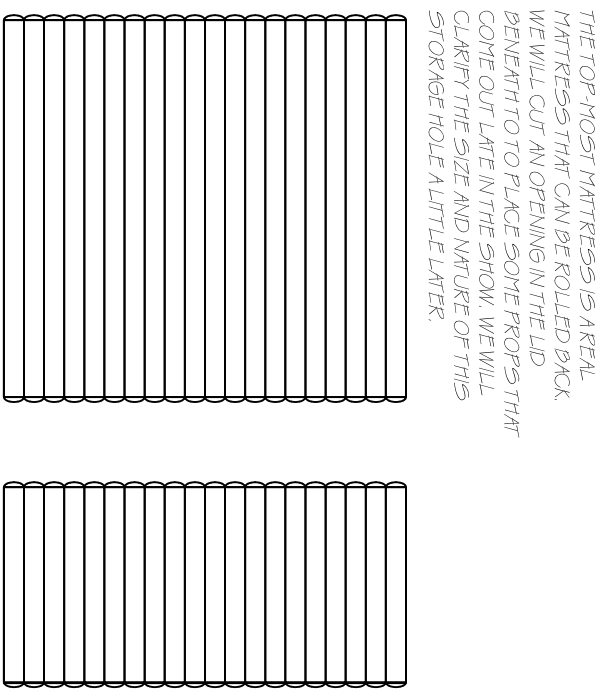

SL CASTLES

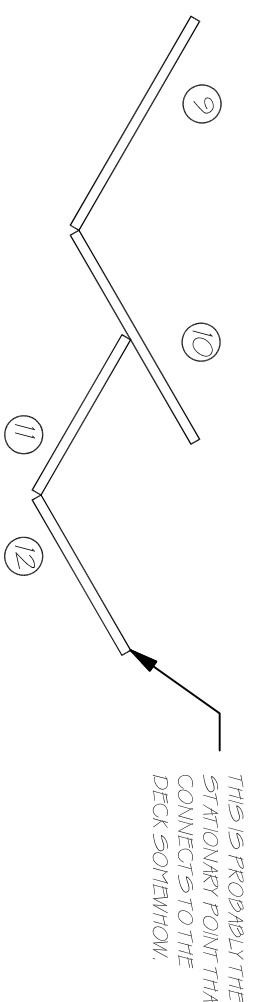
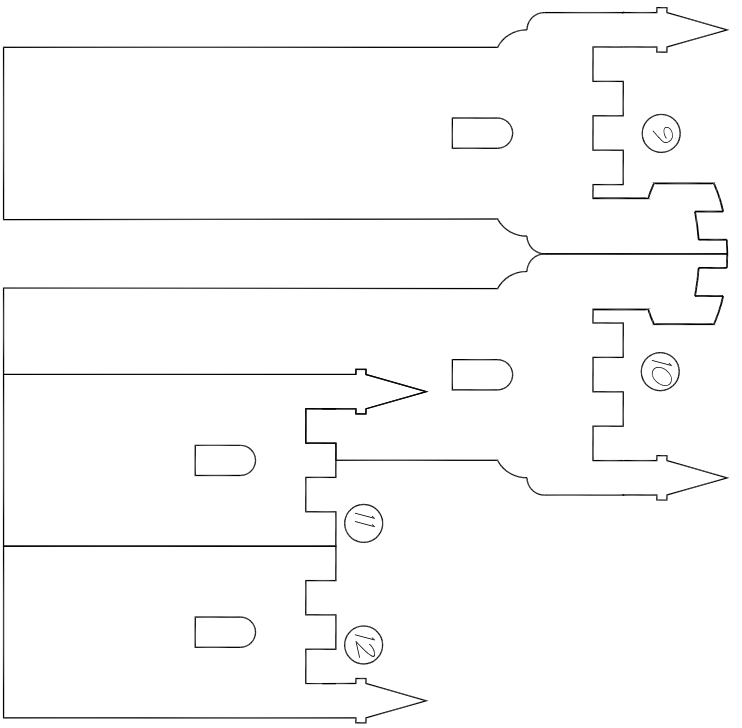

THIS SHOULD BE SHOWN FROM THE CORNER TO THE DECK SOUTHWAY.

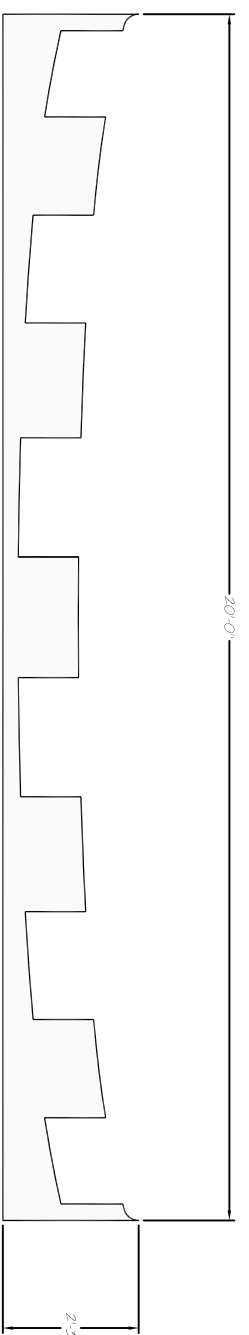
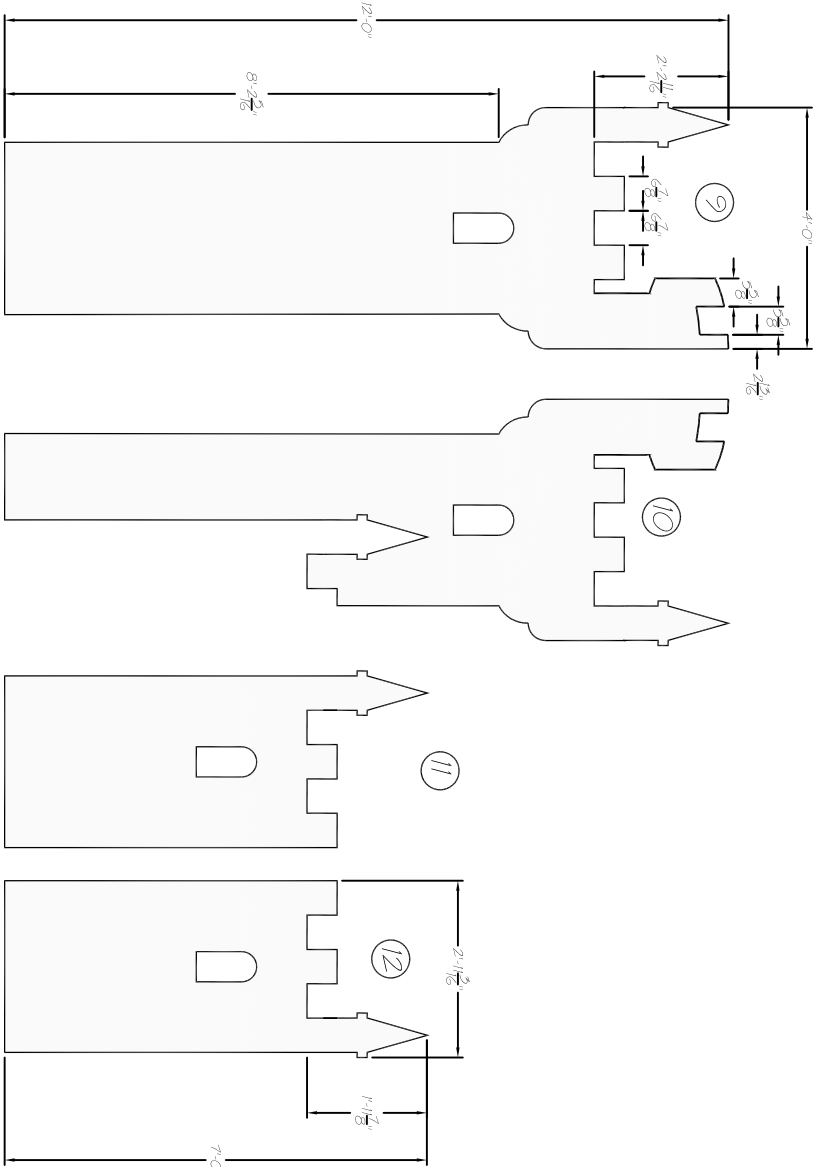

THESE SHOULD BE SHOWN FROM THE CORNER TO THE DECK SOUTHWAY. NO ONE WILL STAND ON IT. IT WILL HAVE AND ONLY ONE. WE OF THEM! THE TOPS SHOULD BE FOUR INCHES THICK.



THESE SHOULD BE SHOWN FROM THE CORNER TO THE DECK SOUTHWAY. NO ONE WILL STAND ON IT. IT WILL HAVE AND ONLY ONE. WE OF THEM! THE TOPS SHOULD BE FOUR INCHES THICK.

THESE SHOULD BE SHOWN FROM THE CORNER TO THE DECK SOUTHWAY. NO ONE WILL STAND ON IT. IT WILL HAVE AND ONLY ONE. WE OF THEM! THE TOPS SHOULD BE FOUR INCHES THICK.

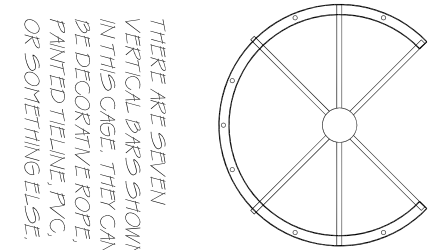

THESE SHOULD BE SHOWN FROM THE CORNER TO THE DECK SOUTHWAY. NO ONE WILL STAND ON IT. IT WILL HAVE AND ONLY ONE. WE OF THEM! THE TOPS SHOULD BE FOUR INCHES THICK.

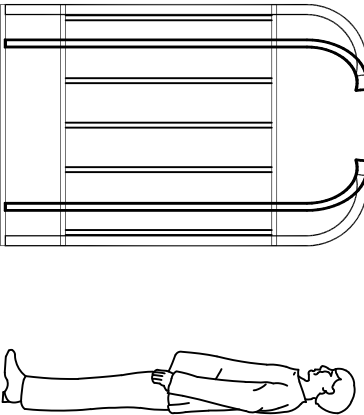

THESE SHOULD BE SHOWN FROM THE CORNER TO THE DECK SOUTHWAY. NO ONE WILL STAND ON IT. IT WILL HAVE AND ONLY ONE. WE OF THEM! THE TOPS SHOULD BE FOUR INCHES THICK.

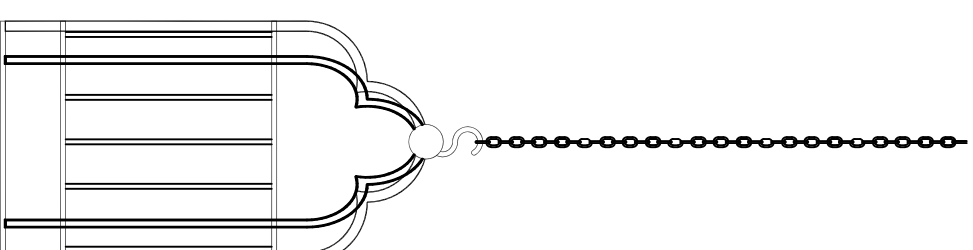

THESE SHOULD BE SHOWN FROM THE CORNER TO THE DECK SOUTHWAY. NO ONE WILL STAND ON IT. IT WILL HAVE AND ONLY ONE. WE OF THEM! THE TOPS SHOULD BE FOUR INCHES THICK.

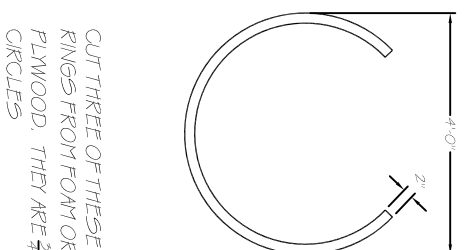

THESE SHOULD BE SHOWN FROM THE CORNER TO THE DECK SOUTHWAY. NO ONE WILL STAND ON IT. IT WILL HAVE AND ONLY ONE. WE OF THEM! THE TOPS SHOULD BE FOUR INCHES THICK.

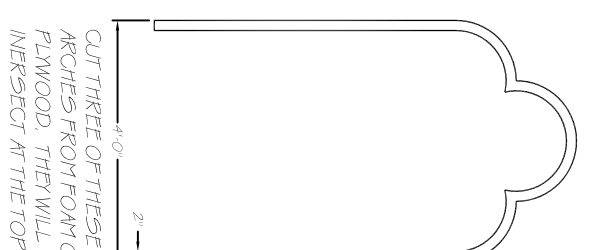

THESE SHOULD BE SHOWN FROM THE CORNER TO THE DECK SOUTHWAY. NO ONE WILL STAND ON IT. IT WILL HAVE AND ONLY ONE. WE OF THEM! THE TOPS SHOULD BE FOUR INCHES THICK.

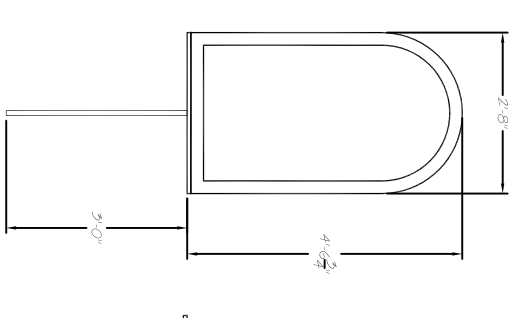

THESE SHOULD BE SHOWN FROM THE CORNER TO THE DECK SOUTHWAY. NO ONE WILL STAND ON IT. IT WILL HAVE AND ONLY ONE. WE OF THEM! THE TOPS SHOULD BE FOUR INCHES THICK.

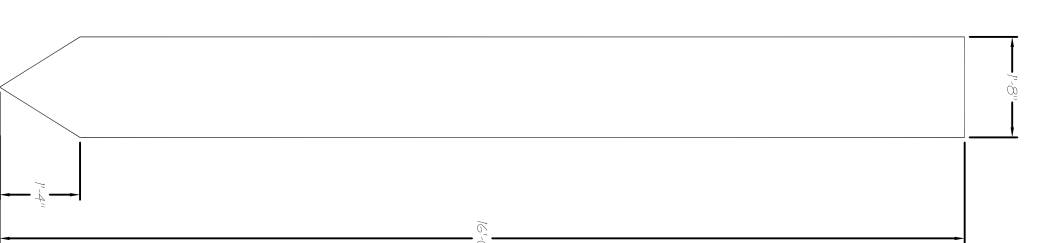

THESE SHOULD BE SHOWN FROM THE CORNER TO THE DECK SOUTHWAY. NO ONE WILL STAND ON IT. IT WILL HAVE AND ONLY ONE. WE OF THEM! THE TOPS SHOULD BE FOUR INCHES THICK.

ONCE UPON A MATTRESS

PLYMOUTH STATE UNIVERSITY
DIRECTED BY FRAN PAGE
SET DESIGN BY MATT KIZER
TECHNICAL DIRECTOR: HEATHER MANFREDI
ELEVATIONS AND DETAILS
SCALE: AS PRINTED

PLATE NO.

4 OF 4

DFT: MK
1*23*24